

Regalschränke 640,740,840 mm für Klappbetten

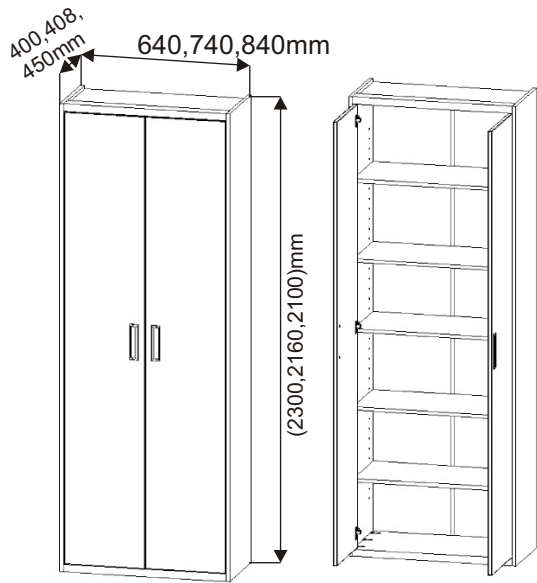

Einglassener Griff + Schrauben 16mm 2x	der Halter 80x	der Verbindungsmechanismus klein 6x	der Verbindungsmechanismus Groß 12x
das Türband 6x	die Leiste (1028-1228 mm-1x) 1000mm-1x 	die Stütze 16x	V 4x16 24x
			V 4x30 8x

1.

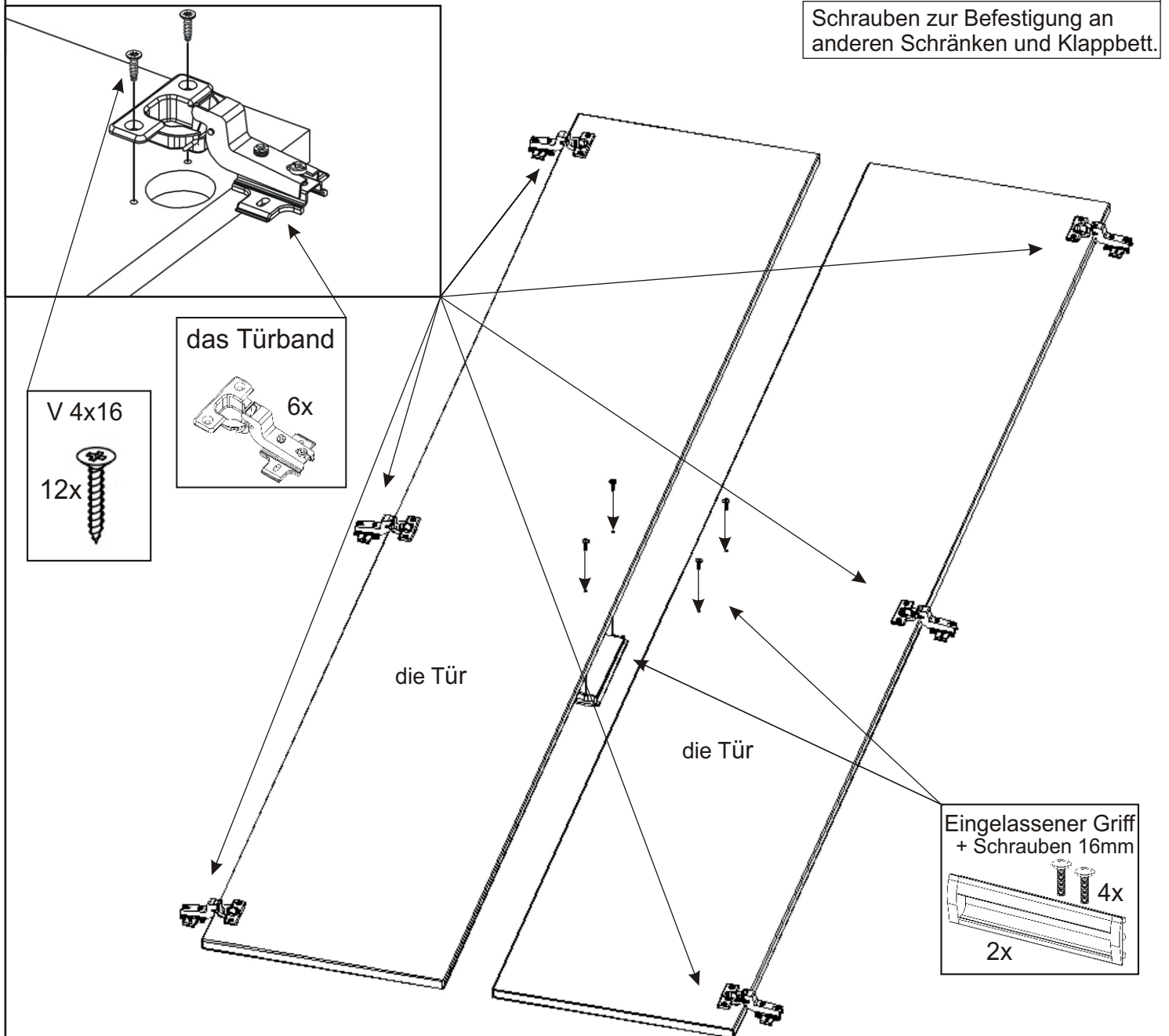

2.

Es ist wichtig, die Exzenter auf beiden Seiten gleichzeitig zu klopfen, um ein Brechen zu vermeiden.

die Stütze

16x

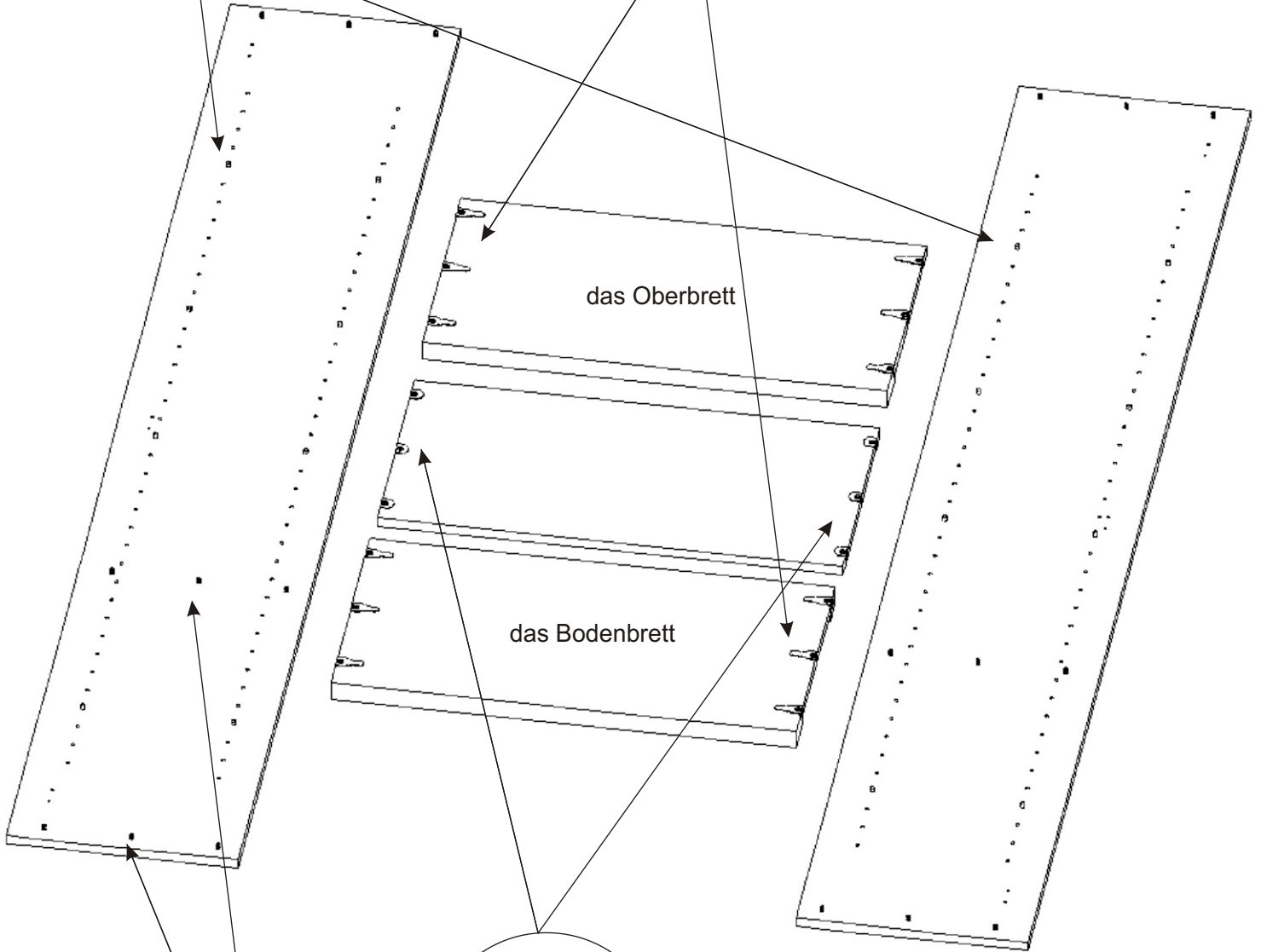
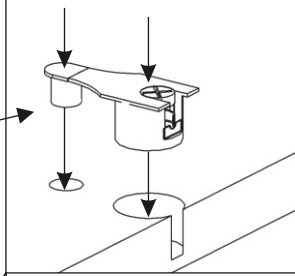
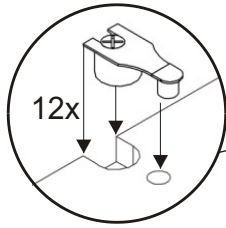
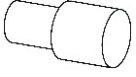

das Oberbrett

das Bodenbrett

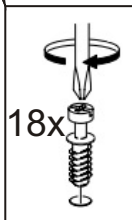
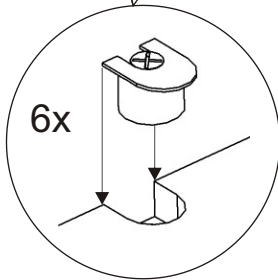

18x

3.

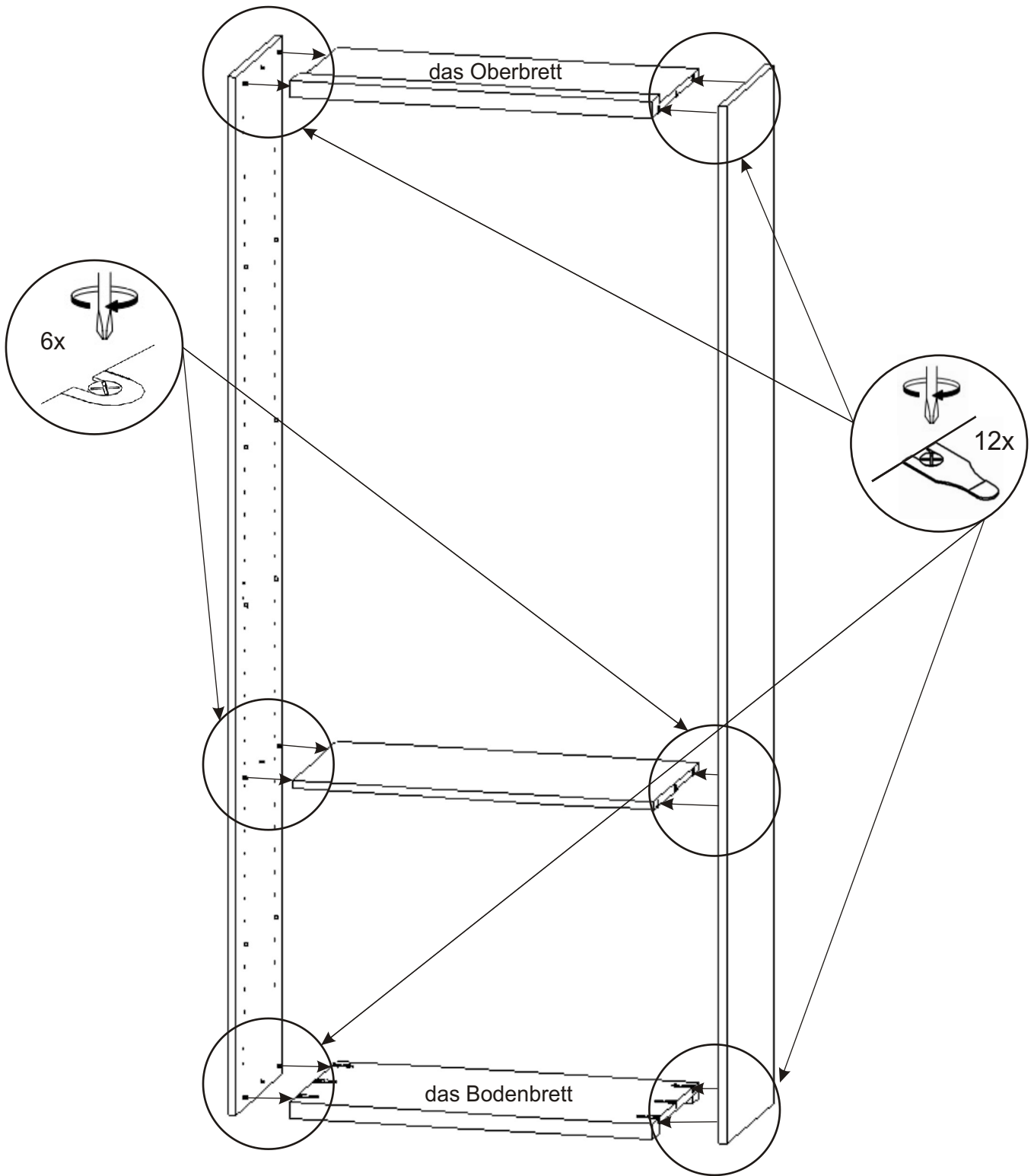

4.

der Halter

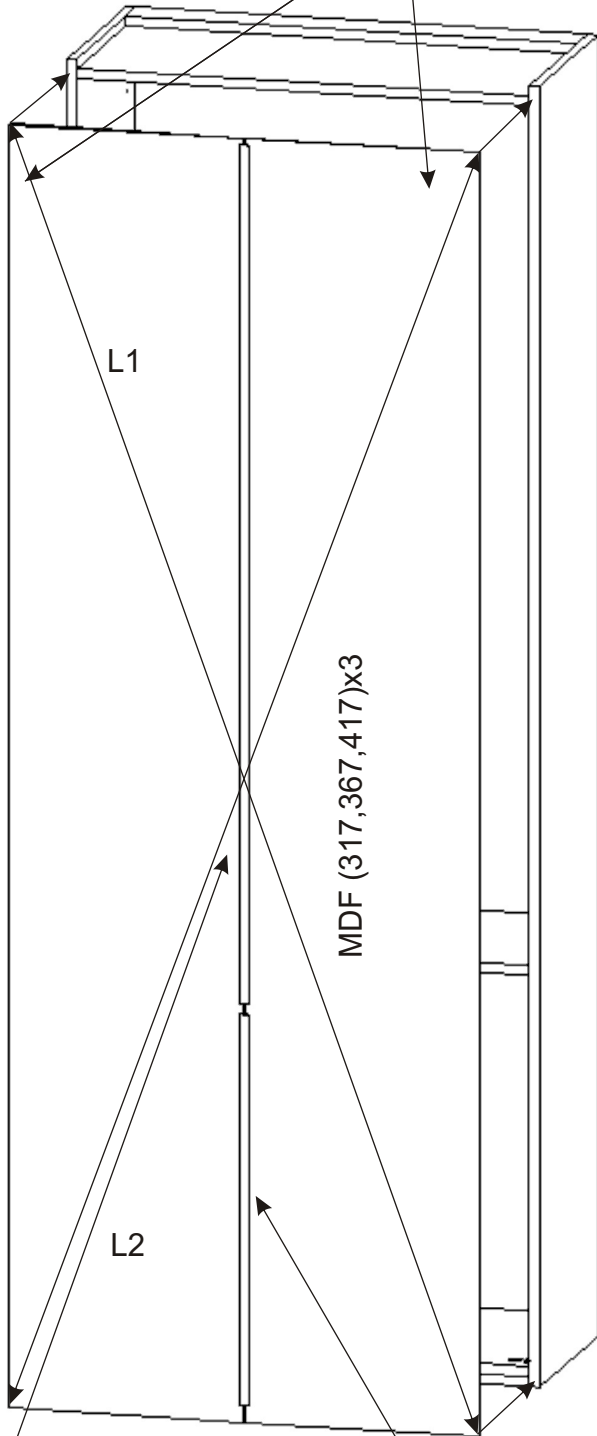

die Leiste
(1028-1228
mm)

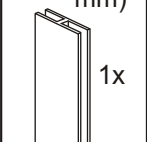

die Leiste
1000mm

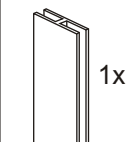

L1 = L2

5.

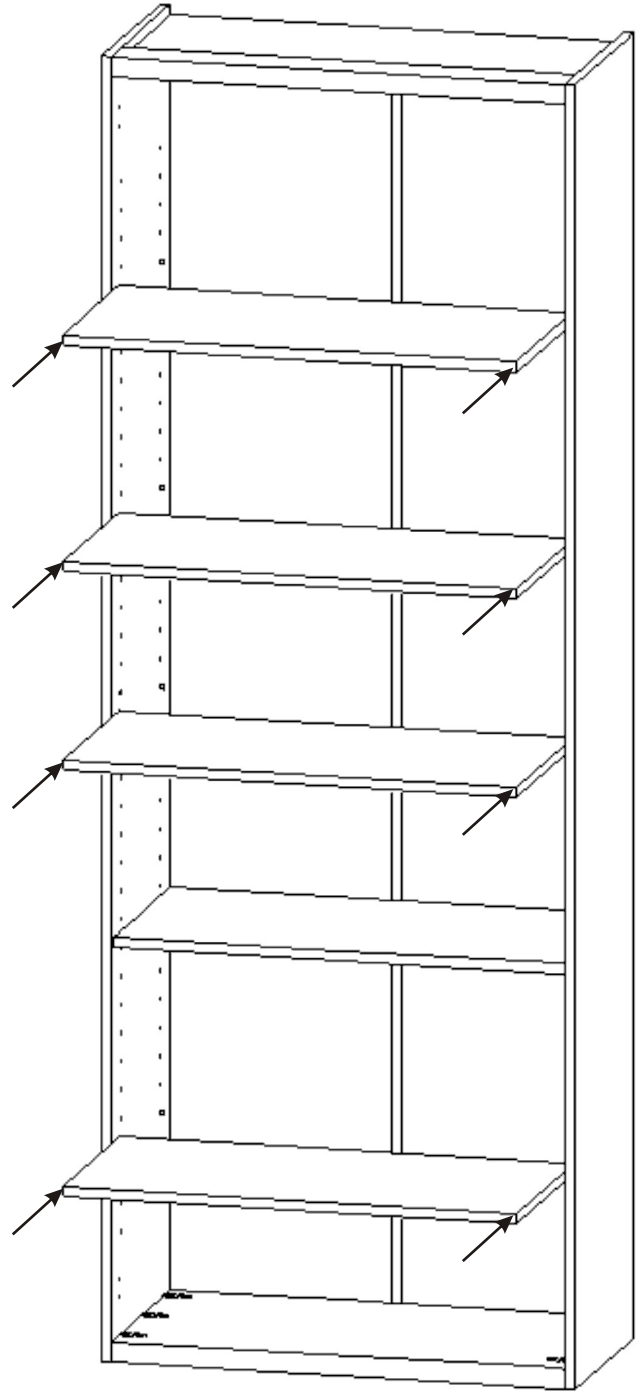

6.

